

THW

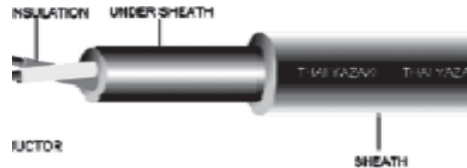

NYY



THW 750 V 70 C SINGLE CORE PVC INSULATED STANDARD TIS 11-2531
สายกลมแกนเดี่ยวหุ้มด้วยฉนวน พีวีซี แรงดัน 750 โวลต์ อุ่นหุ้ม 70 องศาเซลเซียส
ตามมาตรฐาน มอก. 11-2531

NYY 750 V 70 C PVC INSULATED, PVC SHEATHED STANDARD TIS 11-2531
สายส่งกำลังไฟฟ้าชนิดกลมใช้ฝังใต้ดิน หุ้มด้วยฉนวนและเปลือกนอก พีวีซี แรงดัน 750 โวลต์
อุณหภูมิ 70 องศาเซลเซียส ตามมาตรฐาน มอก. 11-2531

| Cross Sectional Area (Sq.mm.) ขนาดพื้นที่หน้าตัด (ตร.มม.) | Price (Baht / Meter) : ราคา (บาท ต่อ เมตร) | | | | |
|---|--|----------|----------|----------|----------|
| | THW | NYY | | | |
| | | 1 Core | 2 Core | 3 Core | 4 Core |
| 0.5 | 1.96 | - | - | - | - |
| 1 | 3.60 | 14.72 | 28.32 | 32.00 | 36.46 |
| 1.5 | 4.78 | 16.33 | 31.46 | 35.92 | 41.38 |
| 2.5 | 7.10 | 19.05 | 37.65 | 44.06 | 51.60 |
| 4 | 10.70 | 25.72 | 53.26 | 63.35 | 76.24 |
| 6 | 17.60 | 38.42 | 73.80 | 91.38 | 111.50 |
| 10 | 30.70 | 46.08 | 104.48 | 134.07 | 170.16 |
| 16 | 47.40 | 62.70 | 147.90 | 196.89 | 249.60 |
| 25 | 74.00 | 91.68 | 217.49 | 292.09 | 372.30 |
| 35 | 99.20 | 124.28 | 288.43 | 394.68 | 543.83 |
| 50 | 142.70 | 164.81 | 412.30 | 555.32 | 707.77 |
| 70 | 201.90 | 223.98 | 546.32 | 751.48 | 983.55 |
| 95 | 277.54 | 300.90 | 733.12 | 1,021.41 | 1,350.37 |
| 120 | 349.33 | 385.41 | 909.98 | 1,288.67 | 1,688.36 |
| 150 | 426.80 | 473.52 | 1,118.47 | 1,570.64 | 2,056.51 |
| 185 | 535.60 | 587.58 | 1,395.01 | 1,954.38 | 2,576.76 |
| | 701.00 | 767.01 | 1,815.43 | 2,555.85 | |
| | 877.00 | 956.68 | 2,259.02 | 3,165.29 | |
| | 1,123.00 | 1,215.48 | - | - | |
| | 1,416.00 | 1,531.91 | - | - | |

หมายเหตุ : ราคานี้อาจเปลี่ยนแปลงได้โดยไม่ต้องแจ้งให้ทราบ

VCT



VFF

VAF

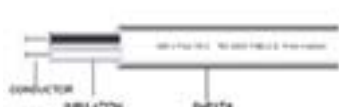

- VAF 300 V 70 C FLAT PVC INSULATED, PVC SHEAHTED STANDARD TIS 11-2531
 สายแบนแกนคู่หุ้มด้วยฉนวนและเปลือกนอก พีวีซี แรงดัน 300 โวลต์ อุ่นหุ้ม 70 องศาเซลเซียส
 ตามมาตรฐาน มอก. 11-2531
- VFF 300 V 70 C FLAT TWIN FLEXIBLE PVC INSULATED STANDARD TIS 11-2531
 สายแบนอ่อนแกนคู่หุ้มด้วยฉนวน พีวีซี แรงดัน 300 โวลต์ อุ่นหุ้ม 70 องศาเซลเซียส
 ตามมาตรฐาน มอก. 11-2531
- VCT 750 V 70 C STRANDED PVC INSULATED, PVC SHEAHTED STANDARD TIS 11-2531
 สายออลชนิดกลมหุ้มด้วยฉนวนและเปลือกนอก พีวีซี แรงดัน 750 โวลต์ อุ่นหุ้ม 70 องศาเซลเซียส
 ตามมาตรฐาน มอก. 11-2531

| Cross Sectional Area (Sq.mm.) ขนาดพื้นที่หน้าตัด (ตร.มม.) | Price (Baht / Meter) : ราคา (บาท ต่อ เมตร) | | | | | |
|---|--|-------|--------|--------|--------|--------|
| | VAF | VFF | VCT | | | |
| | | | 1 Core | 2 Core | 3 Core | 4 Core |
| 0.5 | - | 3.81 | - | 12.85 | 14.90 | 18.90 |
| 0.75 | - | 5.23 | - | 14.60 | 18.30 | 24.20 |
| 1 | 6.00 | 6.38 | - | 17.00 | 23.10 | 28.90 |
| 1.5 | 8.80 | 8.45 | - | 22.60 | 28.70 | 37.10 |
| 2.5 | 13.92 | 11.62 | - | 36.40 | 51.90 | 58.00 |
| 4 | 20.66 | - | - | 52.00 | 65.60 | 83.40 |
| 6 | 30.97 | - | - | 72.95 | 96.10 | 125.00 |
| 10 | 48.72 | - | - | 127.70 | 167.60 | 219.40 |
| 16 | 73.92 | - | - | 188.10 | 243.50 | 313.60 |
| 25 | - | - | - | 274.80 | 365.00 | 469.40 |
| 35 | - | - | - | 364.60 | 490.00 | 633.50 |
| 50 | - | - | - | - | - | - |
| 70 | - | - | - | - | - | - |
| | - | - | - | - | - | - |

VAF-GRD

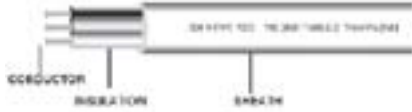

VVF

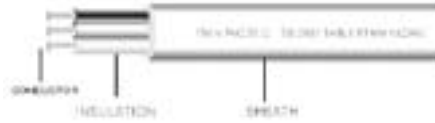

VAF-GRD 300 V 70 C PVC INSULATED AND SHEATHED, FLAT TYPE WITH GROUND
 (TIS. 11-2531 TABLE 11)
 สายแบนแกนคู่มีสายดินหุ้มด้วยฉนวนและเปลือกนอก พี.วี.ซี. แรงดัน 300 โวลต์
 อุนหนุมิ 70 องศาเซลเซียส ตาม มอก. 11-2531 ตารางที่ 11

| Number of Core จำนวนแกน | Cross Sectional Area (Sq.mm.) ขนาดพื้นที่หน้าตัด (ตร.มม.) | Price (Baht/Meter) ราคา (บาท/เมตร) |
|----------------------------|--|---------------------------------------|
| 2 | 1/1 | 15.30 |
| | 1.5/1 | 19.90 |
| | 2.5/1.5 | 27.50 |
| | 4/2.5 | 39.60 |
| | 6/4 | 64.00 |
| | 10/4 | 88.30 |
| | 16/6 | 133.00 |
| | 25/6 | 198.00 |
| | 35/10 | 284.00 |

VVF 750 V 70 C PVC INSULATED, PVC SHEATHED STANDARD TIS 11-2531
 สายแบนแกนคู่หุ้มด้วยฉนวนและเปลือกนอก พี.วี.ซี. แรงดัน 750 โวลต์ อุนหนุมิ 70 องศาเซลเซียส
 ตามมาตรฐาน มอก. 11-2531

| Number of Core จำนวนแกน | Cross Sectional Area (Sq.mm.) ขนาดพื้นที่หน้าตัด (ตร.มม.) | Price (Baht/Meter) ราคา (บาท/เมตร) |
|----------------------------|--|---------------------------------------|
| 2 | 1 | 11.92 |
| | 1.5 | 14.47 |
| | 2.5 | 18.43 |
| | 4 | 27.21 |
| | 6 | 41.43 |
| | 10 | 64.57 |
| | 16 | 96.01 |
| | 25 | 142.72 |
| | 35 | 197.29 |

หมายเหตุ : ราคานี้อาจเปลี่ยนแปลงได้โดยไม่ต้องแจ้งให้ทราบ

VSF

VTF



VSF 300-600 V 70 C PVC INSULATED FLEXIBLE CONDUCTOR STANDARD TIS 11-2531

สายอ่อนเปลือกชนิดกลมหุ้มด้วยฉนวน ตามมาตรฐาน มอก. 11-2531

| VSF : 1 Core | | |
|-------------------------------|------|--------------------|
| Cross Sectional Area (Sq.mm.) | | Price (Baht/Meter) |
| 300 V | 0.5 | 3.18 |
| | 0.75 | 3.94 |
| | 1 | 4.76 |
| | 1.5 | 6.20 |
| | 2.5 | 9.40 |
| 600 V | 4 | 13.58 |
| | 6 | 20.43 |
| | 10 | 35.40 |
| | 16 | 52.17 |
| | 25 | 80.17 |

VTF 300 V 70 C PVC INSULATED TWISTED, FLEXIBLE CONDUCTOR

STANDARD TIS 11-2531

สายอ่อนเปลือกชนิดกลมหุ้มด้วยฉนวน ตามมาตรฐาน มอก. 11-2531

| Number of Core (Sq.mm.) | Price (Baht/Meter) |
|-------------------------|--------------------|
| 2C x 0.5 | 6.05 |
| 2C x 0.75 | 6.90 |
| 2C x 1 | 8.20 |
| 2C x 1.5 | 10.25 |
| 2C x 2.5 | 15.00 |
| 3C x 0.5 | 8.80 |
| 3C x 0.75 | 11.00 |

THW-A



AAC

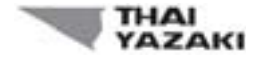
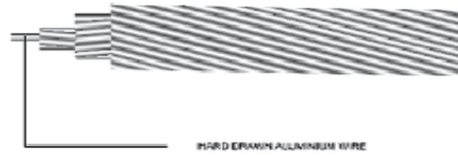

ACSR

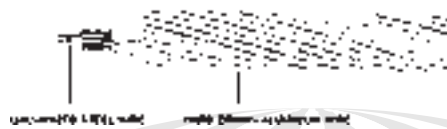

สายอะลูมิเนียมหุ้มฉนวน และสายอะลูมิเนียมเปลือย

THW-A 750V 75 C PVC Insulated aluminum conductor single core.

AAC All Aluminium Conductor.

ACSR All Aluminium Conductor Steel Reinforced.

| Size (Sq.mm.) | THW - A Price (Baht/Meter) | AAC Price (Baht/Meter) | ACSR Price (Baht/Meter) |
|------------------|-------------------------------|---------------------------|----------------------------|
| 10 | 10.00 | - | - |
| 16 | 13.00 | - | - |
| 25 | 18.50 | 14.00 | 16.20 |
| 35 | 26.00 | 19.20 | 22.60 |
| 50 | 40.00 | 27.00 | 31.50 |
| 70 | 46.50 | 38.30 | 45.00 |
| 95 | 62.50 | 52.20 | 62.40 |
| 120 | 82.00 | 67.00 | 81.20 |
| 150 | 99.50 | 82.00 | 120.00 |
| 185 | 116.00 | 110.50 | 141.00 |
| 240 | 152.00 | 127.60 | - |
| 300 | 196.00 | - | - |
| 400 | 246.50 | - | - |
| 500 | 331.00 | - | - |

CVV-F



CVV-S

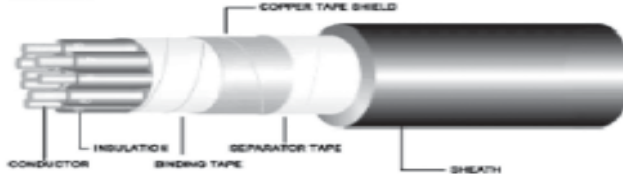

CVV-F 600 V 70 C PVC INSULATED AND SHEATHED CONTROL CABLE

CVV-S 600 V 70 C PVC INSULATED AND SHEATHED CONTROL CABLE WITH SHIELD

| No. of Core | Price (Baht/meter) | | | | | Price (Baht/Meter) | | | | |
|-------------|--------------------|--------|--------|--------|--------|--------------------|--------|--------|--------|--------|
| | CVV-F | | | | | CVV-S | | | | |
| จำนวนแกน | 0.75 | 1 | 1.5 | 2.5 | 4 | 0.75 | 1 | 1.5 | 2.5 | 4 |
| 2 | 23.00 | 24.50 | 27.00 | 36.50 | 50.00 | 42.00 | 44.00 | 49.00 | 61.00 | 81.00 |
| 3 | 25.50 | 28.00 | 33.00 | 46.00 | 63.00 | 46.00 | 50.00 | 56.00 | 73.00 | 97.00 |
| 4 | 32.00 | 33.00 | 40.00 | 57.00 | 84.00 | 54.00 | 57.00 | 66.00 | 87.00 | 118.00 |
| 5 | 39.00 | 43.50 | 51.00 | 73.00 | 102.00 | 63.00 | 68.00 | 78.00 | 106.00 | 140.00 |
| 7 | 46.00 | 52.50 | 63.00 | 92.00 | 133.00 | 73.00 | 80.00 | 95.00 | 128.00 | 176.00 |
| 9 | 61.00 | 71.00 | 86.50 | 123.00 | 176.00 | 90.00 | 99.00 | 115.00 | 160.00 | 218.00 |
| 10 | 66.00 | 76.50 | 94.00 | 135.00 | 194.00 | 98.00 | 107.00 | 125.00 | 175.00 | 245.00 |
| 12 | 73.50 | 86.00 | 106.00 | 156.00 | 229.00 | 106.00 | 117.00 | 140.00 | 195.00 | 272.00 |
| 14 | 81.50 | 94.00 | 118.00 | 175.00 | 258.00 | 117.00 | 130.00 | 154.00 | 216.00 | 318.00 |
| 16 | 87.50 | 103.00 | 130.00 | 196.00 | 298.00 | 125.00 | 142.00 | 170.00 | 242.00 | 357.00 |
| 19 | 99.50 | 117.60 | 150.20 | 228.60 | 346.00 | 140.00 | 160.00 | 190.00 | 278.00 | 400.00 |
| 21 | 112.00 | 133.00 | 168.00 | 254.00 | 383.00 | 153.00 | 173.00 | 207.00 | 315.00 | 452.00 |
| 24 | 124.00 | 147.00 | 188.00 | 294.00 | 433.00 | 171.00 | 194.00 | 234.00 | 355.00 | 518.00 |
| 27 | 139.00 | 160.00 | 209.00 | 324.00 | 483.00 | 186.00 | 210.00 | 257.00 | 389.00 | 567.00 |
| 30 | 148.00 | 175.00 | 229.00 | 356.00 | 532.00 | 198.00 | 227.00 | 284.00 | 424.00 | 620.00 |

CV 0.6/1KV

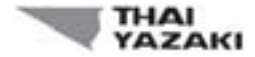
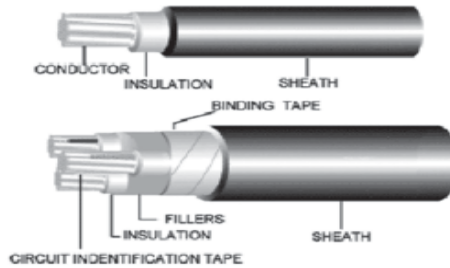

CV 0.6/1KV CU XLPE INSULATED PVC JACKETED POWER CABLE STANDARD IEC 502

| Cross Sectional Area (Sq.mm) ขนาดพื้นที่หน้าตัด (ตร.มม.) | Price (Baht / Meter) : ราคา (บาท ต่อ เมตร) | | | |
|--|--|----------|----------|----------|
| | No. of Core (จำนวนแกน) | | | |
| | 1 Core | 2 Core | 3 Core | 4 Core |
| 2.5 7 ST | 16.30 | 36.90 | 46.20 | 57.00 |
| 4 7 ST | 20.55 | 46.70 | 60.00 | 75.00 |
| 6 7 ST | 27.00 | 61.30 | 79.50 | 100.00 |
| 10 7 ST | 35.60 | 78.40 | 106.60 | 143.60 |
| 16 | 52.20 | 118.90 | 163.80 | 213.70 |
| 25 | 78.70 | 186.00 | 258.90 | 339.40 |
| 35 7 ST | 105.90 | 247.00 | 347.00 | 454.00 |
| 50 | 146.00 | 332.00 | 470.90 | 620.00 |
| 70 | 204.00 | 456.00 | 651.50 | 861.00 |
| 95 | 280.00 | 639.00 | 883.00 | 1,168.00 |
| 120 | 352.00 | 809.00 | 1,129.00 | 1,483.10 |
| 150 | 430.50 | 991.00 | 1,376.00 | 1,825.00 |
| 185 | 539.00 | 1,230.00 | 1,720.00 | 2,272.00 |
| 240 | 704.00 | 1,550.00 | 2,240.00 | 2,961.00 |
| 300 | 882.00 | 1,923.00 | 2,786.00 | 3,880.00 |
| 400 | 1,155.00 | 2,550.00 | 3,600.00 | 4,950.00 |
| 500 | 1,460.00 | - | - | - |
| 630 | 1,850.00 | - | - | - |
| 800 | 2,350.00 | - | - | - |
| 1000 | 3,100.00 | - | - | - |

24 KV- OC (PIC)



33 KV- OC (PIC)



25 KV- CC (SAC)

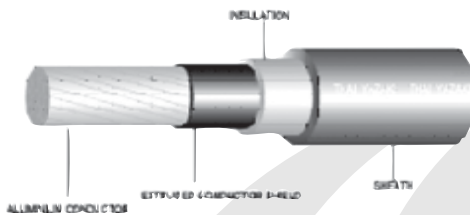

35 KV- CC (SAC)

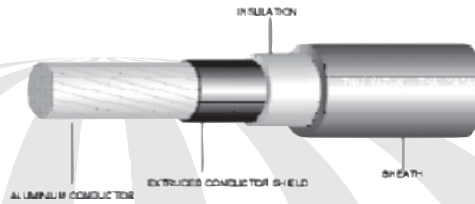

Cross - linked polyethylene partial insulated all aluminium cable (OC)

All aluminium spaced aerial cable (CC)

Standard : IEC 228-1978 , TIS 293-2526 TABLE 2

| Cross Sectional Area (Sq.mm.) พื้นที่หน้าตัด (ตร.มม.) | Price (Baht / Meter) : ราคา (บาท ต่อ เมตร) | | | |
|---|--|-------------------|-------------------|-------------------|
| | 24 KV-OC (PIC) | 33 KV-OC (PIC) | 25 KV-CC (SAC) | 35 KV-CC (SAC) |
| 35 | 46.50 | 61.50 | 114.00 | - |
| 50 | 62.50 | 79.00 | 136.50 | 160.00 |
| 70 | 69.00 | 95.00 | 157.50 | 181.50 |
| 95 | 102.50 | 121.50 | 187.50 | 209.00 |
| 120 | 117.50 | 140.00 | 200.00 | 230.00 |
| 150 | 120.00 | 160.00 | 225.00 | 255.00 |
| 185 | 157.50 | 195.00 | 257.50 | 290.00 |
| 240 | - | - | 309.00 | 339.00 |

1.8/3 (3.6 KV) CV

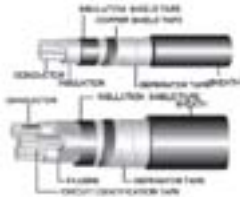

6/10 (12 KV) CV

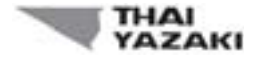
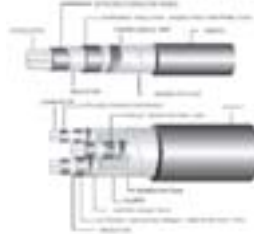

3.6/6 (7.2 KV) CV

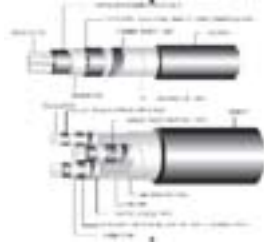

CV : CU XLPE INSULATED, PVC JACKETED POWER CABLE STANDARD IEC 502

สายตัวนำทองแดง หุ้มด้วยฉนวนขรอสลิง พีอี พันเทปทองแดง และเปลือกนอก พีวีซี

1.8/3 (3.6 KV) CV

3.6/6 (7.2 KV) CV

6/10 (12 KV) CV

| Cross Sectional Area (Sq.mm.) ขนาดพื้นที่หน้าตัด (ตร.มม.) | Price (Baht/Meter) : ราคา (บาท ต่อ เมตร) | | | | | |
|---|--|----------|-------------------|----------|-----------------|----------|
| | 1.8/3 (3.6 KV) CV | | 3.6/6 (7.2 KV) CV | | 6/10 (12 KV) CV | |
| | 1C | 3C | 1C | 3C | 1C | 3C |
| 10 | 83.50 | 222.00 | 106.00 | 333.00 | - | - |
| 16 | 106.00 | 292.00 | 132.00 | 407.00 | 164.00 | 510.00 |
| 25 | 138.00 | 390.00 | 164.00 | 512.00 | 198.00 | 523.00 |
| 35 | 169.00 | 488.00 | 200.00 | 620.00 | 235.00 | 738.00 |
| 50 | 211.00 | 630.00 | 244.00 | 773.00 | 283.00 | 892.00 |
| 70 | 280.00 | 835.00 | 311.00 | 982.00 | 353.00 | 1,121.00 |
| 95 | 365.00 | 1,100.00 | 396.00 | 1,253.00 | 441.00 | 1,406.00 |
| 120 | 452.00 | 1,367.00 | 480.00 | 1,523.00 | 528.00 | 1,673.00 |
| 150 | 544.00 | 1,657.00 | 566.00 | 1,796.00 | 620.00 | 1,950.00 |
| 185 | 666.00 | 2,038.00 | 680.00 | 2,152.00 | 749.00 | 2,371.00 |
| 240 | 855.00 | 2,615.00 | 863.00 | 2,755.00 | 956.00 | 3,012.00 |
| 300 | 1,052.00 | 3,230.00 | 1,066.00 | 3,385.00 | 1,169.00 | 3,672.00 |
| 400 | 1,320.00 | 4,052.00 | 1,347.00 | 4,325.00 | 1,463.00 | 4,580.00 |
| 500 | 1,670.00 | - | 1,722.00 | - | - | - |



8.7/15 (17.5) KV-CV

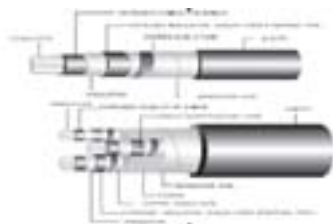

12/20 (24) KV-CV

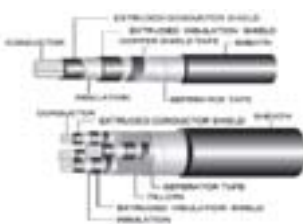

18/30 (36) KV-CV

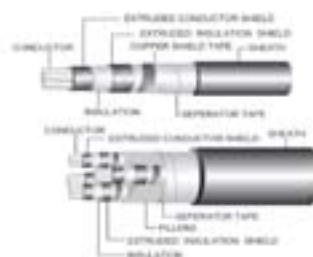

CV : CU XLPE INSULATED, PVC JACKETED POWER CABLE STANDARD IEC 502

สายตัวนำทองแดง หุ้มด้วยฉนวนครอสลิง พิอี พันเทปทองแดง และเปลือกนอก พิวีซี

8.7/15 (17.5) KV-CV

12/20 (24) KV-CV

18/30 (36) KV-CV

| Cross Sectional Area (Sq.mm.) ขนาดพื้นที่หน้าตัด (ตร.มม.) | Price (Baht/Meter) : ราคา (บาท ต่อ เมตร) | | | | | |
|---|--|----------|------------------|----------|------------------|----------|
| | 8.7/15 (18 KV) CV | | 12/20 (24 KV) CV | | 18/30 (36 KV) CV | |
| | 1C | 3C | 1C | 3C | 1C | 3C |
| 25 | 226.00 | 722.00 | - | - | - | - |
| 35 | 265.00 | 842.00 | 293.00 | 942.00 | 403.00 | 1,325.00 |
| 50 | 312.00 | 1,011.00 | 344.00 | 1,105.00 | 424.00 | 1,403.00 |
| 70 | 386.00 | 1,236.00 | 415.00 | 1,335.00 | 499.00 | 1,675.00 |
| 95 | 476.00 | 1,519.00 | 506.00 | 1,655.00 | 595.00 | 1,975.00 |
| 120 | 564.00 | 1,870.00 | 599.00 | 1,938.00 | 686.00 | 2,281.00 |
| 150 | 654.00 | 2,117.00 | 688.00 | 2,228.00 | 785.00 | 2,579.00 |
| 185 | 778.00 | 2,485.00 | 809.00 | 2,634.00 | 911.00 | 2,969.00 |
| 240 | 989.00 | 3,110.00 | 1,013.00 | 3,378.00 | 1,108.00 | 3,728.00 |
| 300 | 1,202.00 | 3,844.00 | 1,233.00 | 3,984.00 | 1,306.00 | 4,447.00 |
| 400 | 1,499.00 | 4,683.00 | 1,530.00 | 4,832.00 | 1,612.00 | 5,325.00 |



NYY-N

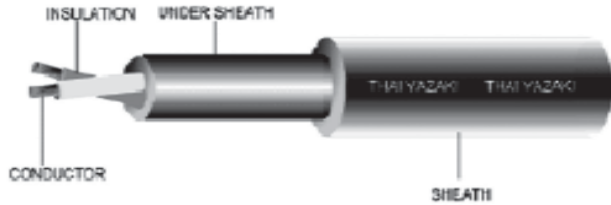

NYCY

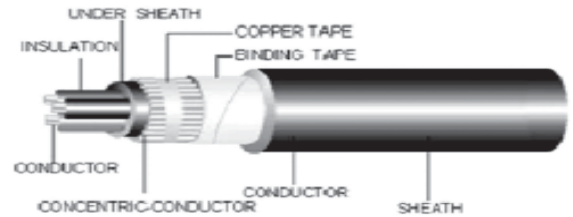

NYY-N 750 V 70 C PVC INSULATED, PVC SHEATHED WITH REDUCED NEUTRAL STANDARD TIS11-2531

สายส่งกำลังไฟฟ้าชนิดกลมใช้ฝังใต้ดิน หุ้มด้วยฉนวนและเปลือกนอก พีวีซี มีสายศูนย์ แรงดัน 750 โวลต์ 70 องศาเซลเซียส ตามมาตรฐาน มอก. 11-2531

NYCY 750 V 70 C PVC INSULATED, PVC SHEATHED UNDERGROUND POWER CABLE WITH COPPER CONCENTRIC CONDUCTORS STANDARD TIS 11-2531

สายส่งกำลังไฟฟ้าชนิดกลมใช้ฝังใต้ดิน หุ้มด้วยฉนวนและเปลือกนอก พีวีซี มีลวดทองแดงพัน ภายในหนึ่งชั้น แรงดัน 750 โวลต์ 70 องศาเซลเซียส ตามมาตรฐาน มอก. 11-2531

| Number of Core จำนวนแกน | Cross Sectional Area (Sq.mm.) ขนาดพื้นที่หน้าตัด (ตร.มม.) | Price (Baht / Meter) | |
|----------------------------|--|----------------------|----------|
| | | NYY-N | NYCY |
| 3 | 25/16 | 358.14 | 390.61 |
| | 35/16 | 474.54 | 484.81 |
| | 50/25 | 672.20 | 717.93 |
| | 70/35 | 899.12 | 918.28 |
| | 95/50 | 1,197.12 | 1,234.88 |
| | 120/70 | 1,502.71 | 1,563.55 |
| | 150/70 | 1,790.79 | 1,872.20 |
| | 185/95 | 2,220.86 | 2,321.72 |
| | 240/120 | 3,014.70 | 3,145.53 |
| | 300/150 | 3,713.36 | 3,864.37 |



750 V 70°C PVC INSULATED AND DOUBLE SHEATHED ROUND TYPE, WITH GROUND

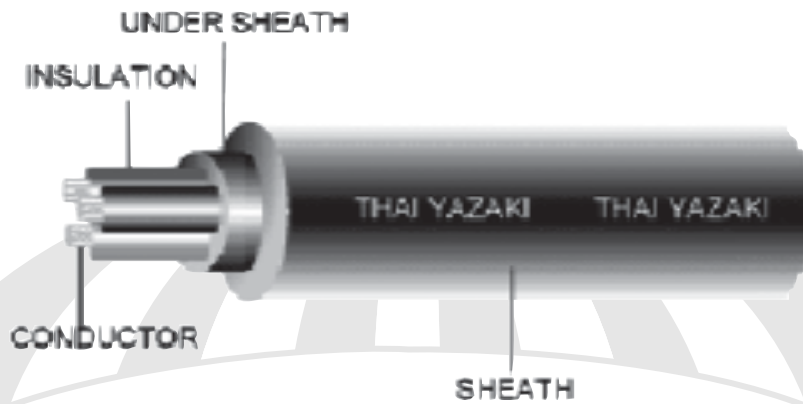

NYY-GRD

CABLE STRUCTURE

| | | |
|------------------|---|---|
| NUMBER OF CORE | : | 2 up to 4 cores with safety ground |
| CONDUCTOR | : | Solid and stranded copper, Sizes, 1 mm ² up to 300 mm ² Ground conductor sizes 1 mm ² up to 35 mm ² |
| INSULATION | : | PVC Colour : 2 core-Light grey, Black 3 core-Light grey, Black, Red 4 core-Light grey, Black, Red, Blue Ground core-Green/Yellow |
| SHEATH AND UNDER | : | PVC |
| SHEATH | : | Colour : Black |
| CLASSIFICATION | : | Maximum conductor temperature 70°C Circuit voltage not exceeding 750 volts |
| VOLTAGE | : | 2,500 volts |
| STANDARD | : | TIS 11-2531, Table 14 |



750 V 70°C PVC INSULATED AND DOUBLE SHEATHED POWER CABLE, WITH GALVANIZED STEEL WIRES ARMOUR

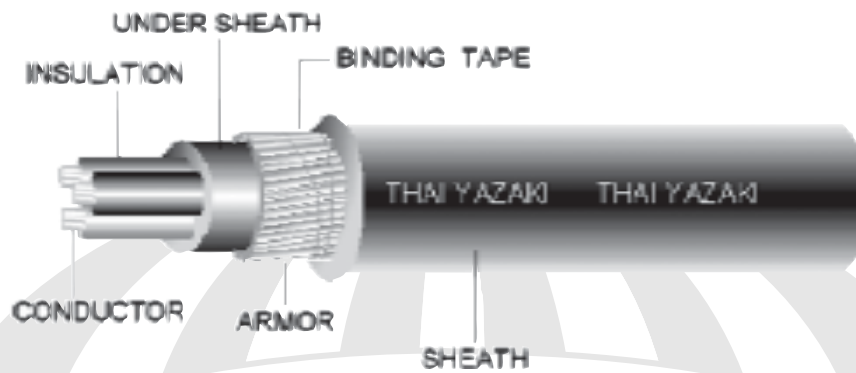

NYY-SWA

CABLE STRUCTURE

| | | |
|----------------|---|--|
| NUMBER OF CORE | : | 2 cores up to 4 cores |
| CONDUCTOR | : | Solid and stranded annealed copper, Sizes, 1 mm ² up to 300 mm ² |
| INSULATION | : | PVC Colour : 2 core-Light grey, Black 3 core-Light grey, Black, Red 4 core-Light grey, Black, Red, Blue |
| UNDER SHEATH | : | PVC, Black Colour |
| SHEATH | : | PVC, Black Colour |
| ARMOUR | : | Galvanized Steel Wires |
| CLASSIFICATION | : | Maximum conductor temperature 70°C Circuit voltage not exceeding 750 volts |
| VOLTAGE | : | 2,500 volts |
| CE | : | TIS 11-2531 |

บริษัท พี.เอส. พัฒนกร จำกัด

44/151 ซอยรามอินทรา 65, ถนนรามอินทรา
แขวงท่าแร้ง เขตบางเขน กรุงเทพฯ 10230
โทร : 66-2945-7288 แฟกซ์ : 66-2945-7291
อี-เมล : ps_sales@pspattanakorn.com
เว็บไซต์ : www.pspattanakorn.com



P.S. PATTANAKORN CO., LTD.

44/151 Soi Ramintra 65, Ramintra Road
Tharang, Bangkok, Bangkok 10230, Thailand
Tel : 66-2945-7288 Fax : 66-2945-7291
Email : ps_sales@pspattanakorn.com
Web site : www.pspattanakorn.com



| Cross Sectional Area (Sq.mm.) | Price (Baht/Meter) | | | Cross Sectional Area (Sq.mm.) | Price (Baht/Meter) | | |
|-------------------------------------|--------------------|--------|--------|-------------------------------------|--------------------|----------|----------|
| | NYN-GRD | | | | NYN-SWA | | |
| | 2 | 3 | 4 | | 2 | 3 | 4 |
| 1.5/1 | 44.00 | 52.90 | 67.90 | 50/10 | 370.69 | 496.13 | 629.65 |
| 2.5/1.5 | 51.50 | 65.90 | 84.90 | 70/10 | 478.43 | 632.64 | 812.25 |
| 4/2.5 | 71.10 | 89.90 | 110.90 | 95/16 | 632.74 | 847.37 | 1,95.47 |
| 6/4 | 96.90 | 124.50 | 158.50 | 120/16 | 775.51 | 1,054.59 | 1,352.00 |
| 10/4 | 135.20 | 175.60 | 225.60 | 150/25 | 965.45 | 1,294.94 | 1,672.00 |
| 16/6 | 192.20 | 272.30 | 326.40 | 185/25 | 1,073.78 | 1,567.92 | 2,033.00 |
| 25/6 | 286.30 | 376.00 | 475.00 | 240/35 | 1,432.92 | 2,040.39 | 2,684.00 |
| 35/10 | 391.40 | 515.60 | 674.00 | 300/35 | 1,740.00 | 2,504.22 | 3,287.00 |
| 50/10 | - | 676.60 | 866.00 | | | | |





INSIDE - OUTSIDE STATION WIRE

TIEV-CC



GENERAL

This specification covers the requirements of inside-outside station wire used for direct connection from the outside protector to the subscriber's set by The Telephone Organization of Thailand (TOT).

| Sizes (Sq.mm.) ขนาด (ตร.มม.) | Price (Baht / Meter) Price (Baht/Meter) : ราคา (บาท ต่อ เมตร) |
|---------------------------------|--|
| 2 C x 0.5 Sq.mm. | 3.50 |
| 3 C | 4 |
| 4 C | 4.90 |
| 5 C | 5.80 |
| 6 C | 6.70 |
| 2 C x 0.65 Sq.mm. | 4.40 |
| 3 C | 5.40 |
| 4 C | 6.90 |
| 5 C | 8.30 |
| 6 C | 9.50 |

POLYETHYLENE INSULATION
 PVC SHEATHED CABLE
 ANNEALED COPPER CONDUCTOR



TPEV-CC, TPUEV-CC

GENERAL

This specification covers the requirements of copper conductor polyethylene insulated and polyvinyl chloride sheathed cable, to be used for connecting subscriber equipments inside the building

| No. of Pair จำนวนคู่ | TPEV-CC | |
|-------------------------|--|--------------------------------------|
| | Price(Baht/Meter) : ราคา(บาท ต่อ เมตร) | |
| | Size 0.5 Sq.mm. ขนาด 0.5 ตร.มม. | Size 0.65 Sq.mm. ขนาด 0.65 ตร.มม. |
| 4P | 18.50 | 21.50 |
| 5P | 20.00 | 25 |
| 6P | 21.00 | 28 |
| 8P | 25 | 32 |
| 10P | 28 | 37 |
| 12P | 40 | 52 |
| 15P | 45 | 61 |
| 20P | 56 | 75 |
| 25P | 65 | 92 |
| 30P | 82 | 110 |
| 40P | 104.20 | 136 |
| 50P | 119.85 | 165 |
| 100P | 203.50 | 303 |
| 150P | 295.30 | 443 |

ALPETH SHEATHED CABLE

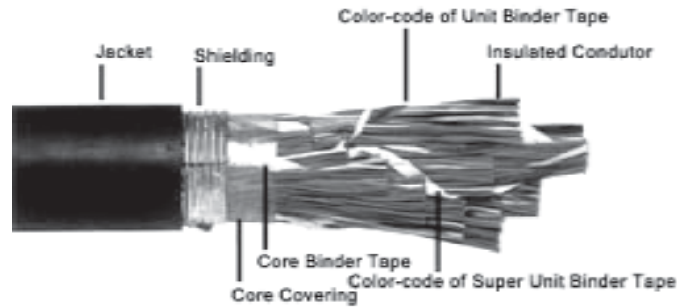

GENERAL

This specification covers the requirements for polyethylene insulation alpeth sheathed cable, intended for aerial installation by attachment to a separate support strand. The cable shall be used on subscriber and junction line.

| No. of pair (จำนวนคู่) | Size 0.4 Sq.mm. ขนาด 0.4 ตร.มม. | Size 0.5 Sq.mm. ขนาด 0.5 ตร.มม. | Size 0.65 Sq.mm. ขนาด 0.65 ตร.มม. | Size 0.9 Sq.mm. ขนาด 0.9 ตร.มม. |
|---------------------------|------------------------------------|------------------------------------|--------------------------------------|------------------------------------|
| 10 | 39 | 49 | 63 | 102 |
| 25 | 65 | 86 | 119 | 209 |
| 50 | 106 | 146 | 209 | 394 |
| 100 | 180 | 262 | 388 | 736 |
| 150 | 269 | 391 | 575 | 1,101 |
| 200 | 345 | 509 | 755 | 1,470 |
| 300 | 502 | 739 | 1,097 | 2,151 |
| 400 | 650 | 965 | 1,450 | 2,837 |
| 600 | 948 | 1,428 | 2,157 | 4,213 |
| 900 | 1,390 | 2,089 | 3,194 | - |

FOAM/SKIN
 INSULATION ALPETH
 SHEATHED, FILLED CABLE



AP-FSF

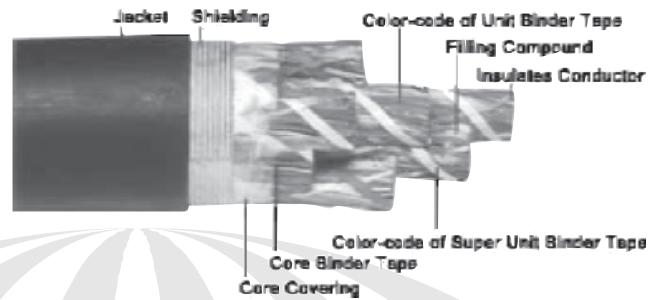

GENERAL

This cable is designed for use as a duct cable in either exchange area service or trunk service. The cable is foam-skin Polyethylene insulated, fully color coded, and fully filled with a filling compound to prevent the penetration and migration of water.

| No. of pair (จำนวนคู่) | Size 0.4 Sq.mm. ขนาด 0.4 ตร.มม. | Size 0.5 Sq.mm. ขนาด 0.5 ตร.มม. | Size 0.65 Sq.mm. ขนาด 0.65 ตร.มม. | Size 0.9 Sq.mm. ขนาด 0.9 ตร.มม. |
|---------------------------|------------------------------------|------------------------------------|--------------------------------------|------------------------------------|
| 50 | 125 | 170 | 248 | 466 |
| 100 | 210 | 304 | 445 | 857 |
| 150 | 313 | 460 | 661 | 1,307 |
| 200 | 397 | 588 | 862 | 1,698 |
| 300 | 568 | 851 | 1,297 | 2,500 |
| 400 | 739 | 1,108 | 1,680 | 3,320 |
| 600 | 1,074 | 1,621 | 2,498 | 4,892 |
| 900 | 1,585 | 2,376 | 3,698 | - |
| 1200 | 2,065 | 3,133 | 4,849 | - |
| 1500 | 2,562 | 3,906 | - | - |
| 1800 | 3,076 | 4,623 | - | - |
| | 4,050 | - | - | |
| | 4,525 | - | - | |
| | 5,026 | - | - | |

FIGURE 8 ALPETH SHEATHED CABLE



AP(8)

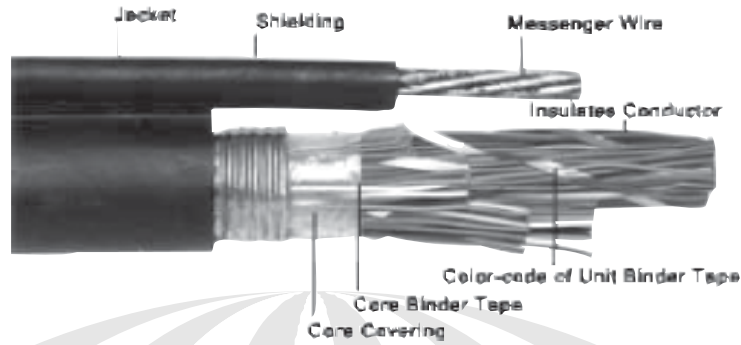

GENERAL

This specification covers the requirements for telephone cable 0.4,0.5,0.65 and 0.9 mm. gauges copper conductor. Fully color coded even count polyethylene insulated twinned until stranded and alpeth sheathed for aerial installation. The cable shall be used on subscriber and junction line.

| No. of pair (จำนวนคู่) | Size 0.4 Sq.mm. ขนาด 0.4 ตร.มม. | Size 0.5 Sq.mm. ขนาด 0.5 ตร.มม. | Size 0.65 Sq.mm. ขนาด 0.65 ตร.มม. | Size 0.9 Sq.mm. ขนาด 0.9 ตร.มม. |
|---------------------------|------------------------------------|------------------------------------|--------------------------------------|------------------------------------|
| 10 | 78 | 87 | 100 | 140 |
| 25 | 102 | 125 | 157 | 247 |
| 50 | 146 | 187 | 247 | 440 |
| 100 | 221 | 305 | 434 | 784 |
| 150 | 311 | 438 | 624 | 1,165 |
| 200 | 388 | 555 | 802 | 1,529 |

PVC INSULATED JUMPER WIRE

TJV



GENERAL

This specification covers the requirements of jumper wire used for cross connecting purposes and main distribution frame wiring by The Telephone Organization of Thailand (TOT).

| No. Of cores nominal | Conductor Diameter : 0.5 mm | | Conductor Diameter : 0.65 mm | |
|----------------------|-----------------------------|-----------------|------------------------------|-----------------|
| | Overall Dia.(mm) | Standard Length | Overall Dia.(mm) | Standard Length |
| 2 | 2 | 200 | 3 | 200 |
| 3 | 3 | 200 | 3 | 200 |
| 4 | 3 | 200 | 4 | 200 |
| 5 | 3 | 200 | 4 | 200 |

** กรุณาสอบถามราคา **

PVC INSULATED AND SELF-SUPPORTED TELEPHONE DROP-WIRE

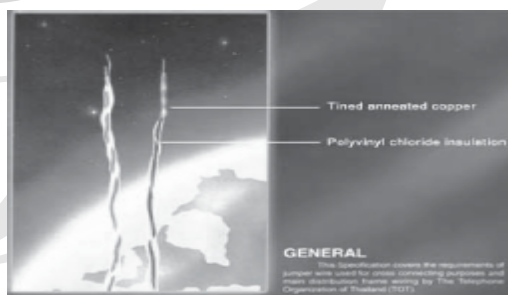

S-S DROP WIRE

| Conductor Diameter and No. of Core/Pair | Overall Dia. Approx.(mm) | Cable Weight Approx.(kg/km) | Standard Length (m) | Price (฿) |
|---|--------------------------|-----------------------------|---------------------|-------------|
| 0.65 MM. x 2C | 7 | 42 | 200 | กรุณาสอบถาม |
| 0.9 MM. x 2C | 8 | 52 | 200 | กรุณาสอบถาม |
| | 8 | 58 | 200 | กรุณาสอบถาม |
| | 9 | 80 | 200 | กรุณาสอบถาม |